

VT6EE / VT6EES - 066 - 045 - 1 R 00 - B 1 0 - 00 \*

### Series

VT6EE Series - 250 B4HW  
ISO 3019-2 mounting flange  
VT6EES Series - SAE 4 bolts  
Mounting flange J744c

### Cam ring for "P1" & "P2"

Volumetric displacement cm<sup>3</sup>/rev (in<sup>3</sup>/rev)

- 042 = 132.3 (8.07)
- 045 = 142.4 (8.69)
- 050 = 158.5 (9.67)
- 052 = 164.8 (10.06)
- 057 = 180.7 (11.02)
- 062 = 196.7 (12.00)
- 066 = 213.3 (13.02)
- 072 = 227.1 (13.86)
- 085 = 269.8 (16.46)

### Type of Shaft VT6EE

2 - Keyed (G45N ISO 3019-2)

### VT6EES

- 1 - Keyed (SAE CC)
- 3 - Splined (SAE CC)
- 4 - Splined (SAE D&E)
- 5 - Keyed (SAE D&E)

P1 P2

### Modifications

#### Port connection variables

SAE 4 bolt flange (J518c)

	UNC	METRIC
VT6EE		M0
VT6EES	00	M0

#### Coupling adaptor

- 0 - None
- 2 - SAE B
- 3 - SAE BB

#### Seal class

- 1 - S1 (for mineral oil)
- 4 - S4 (for fire resistant fluids)
- 5 - S5 (for mineral oil and fire resistant fluids)

#### Design letter

#### Porting combination (see page BM-1-5)

00 = Standard

#### Direction of rotation (View on shaft end)

- R - Clockwise
- L - Counter - clockwise



### INTERNAL LEAKAGE (TYPICAL)

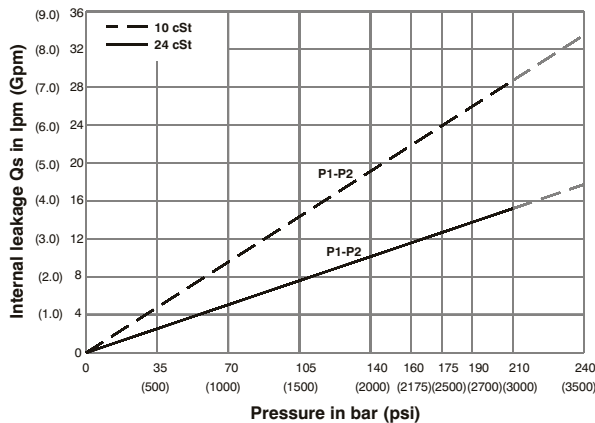

Do not operate pump more than 5 seconds at any speed or viscosity if internal leakage is more than 50% of theoretical flow. Total leakage is the sum of each section loss at its operating conditions.

### NOISE LEVEL (TYPICAL)

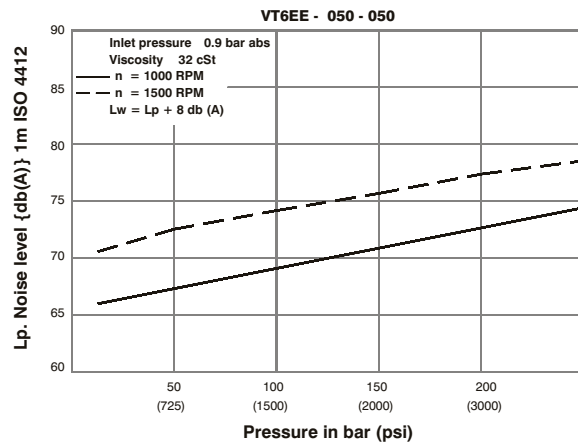

Double pump noise level is given with each section discharging at the pressure noted on the curve.

### HYDROMECHANICAL POWER LOSS (TYPICAL)

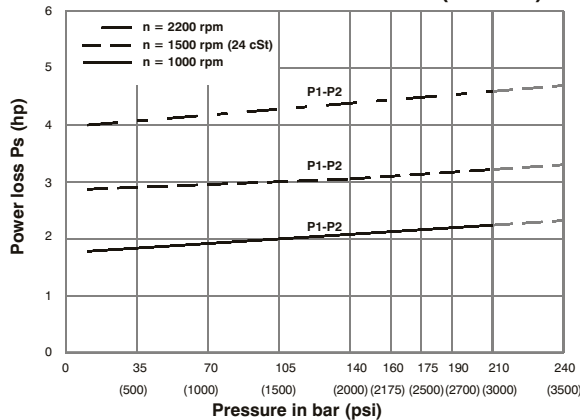

Total hydromechanical power loss is the sum of each section at its operating conditions.

### PERMISSIBLE RADIAL LOAD

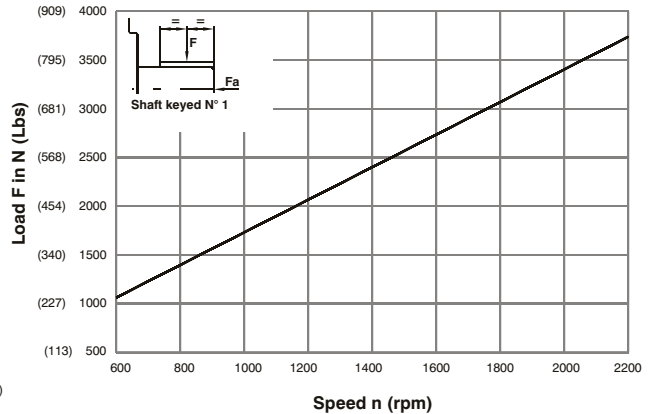

Maximum permissible axial load  $F_a = 2000$  N (449 Lbs)

# HIGH PERFORMANCE VANE PUMP VT6EE/ VT6EES



DP

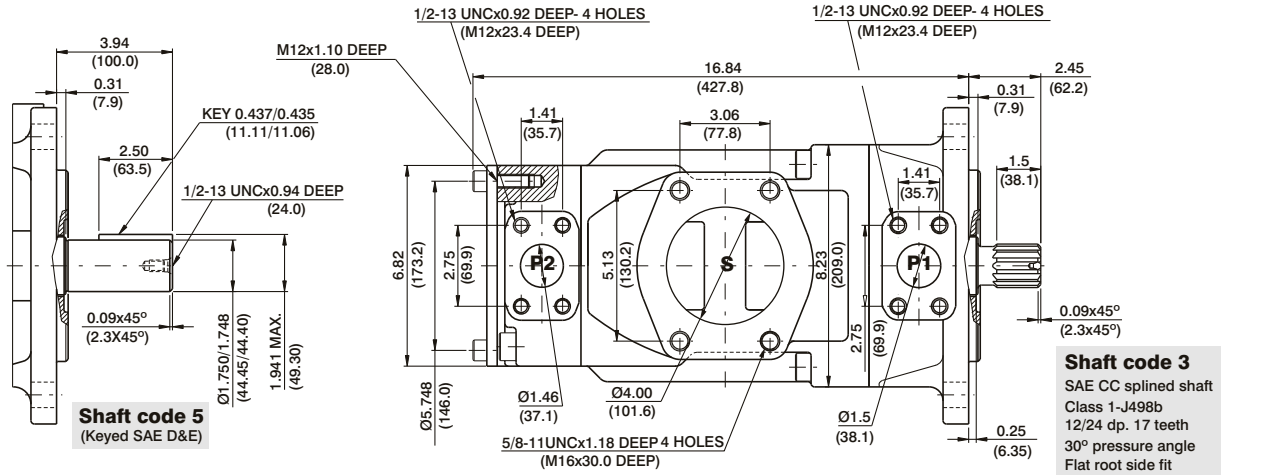

**Shaft code 5**  
(Keyed SAE D&E)

**Shaft code 3**  
SAE CC splined shaft  
Class 1-J498b  
12/24 dp. 17 teeth  
30° pressure angle  
Flat root side fit

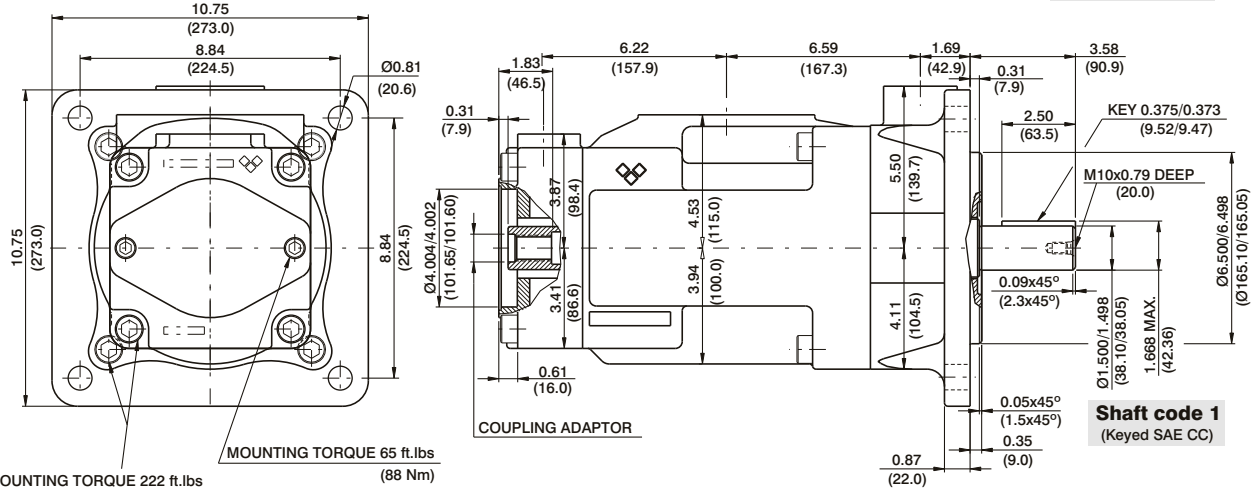

MOUNTING TORQUE 222 ft.lbs  
(300 Nm)

MOUNTING TORQUE 65 ft.lbs  
(88 Nm)

COUPLING ADAPTOR

**Shaft code 1**  
(Keyed SAE CC)

## VT6EE

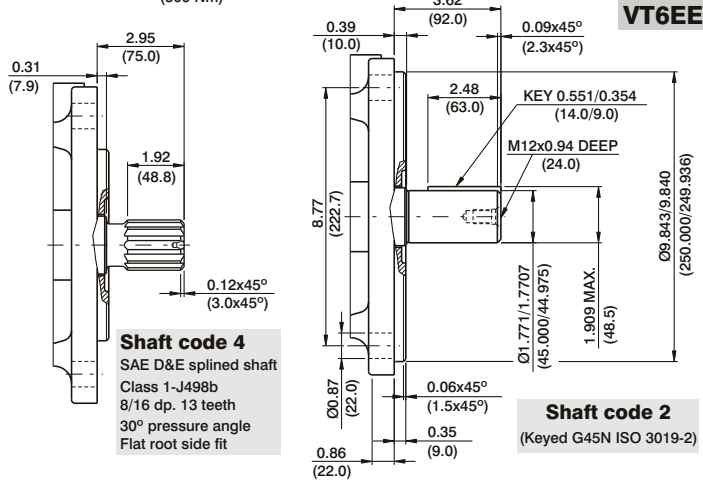

**Shaft code 4**  
SAE D&E splined shaft  
Class 1-J498b  
8/16 dp. 13 teeth  
30° pressure angle  
Flat root side fit

**Shaft code 2**  
(Keyed G45N ISO 3019-2)

### Shaft torque limits in<sup>3</sup>/rev x psi (ml/rev x bar)

Shaft	Vi x p Max.	Copling	Vi x p Max.
1	80053 (90380)	SAE-B	18246 (20600)
2	101506 (114600)	SAE-BB	28937 (32670)
3	112312 (126800)		
4	112312 (126800)		
5	104818 (110840)		

### Code Coupling adaptor

Code	Coupling adaptor
0	Without coupling
2	SAE B -13 teeth -pitch 16/32 Major dia (min) 0.875 (22.225) Minor dia (min.) 0.753 (19.126)
3	SAE BB -15 teeth -pitch 16/32 Major dia (min) 1.00 (25.4) Minor dia (min.) 0.877 (22.275)

## OPERATING CHARACTERISTICS - TYPICAL (24 cST) (Input power p (KW) for one cartridge only)

Pressure port	Series	Volumetric Displacement Vp	Flow q & n = 1500 rpm						Input power p & n = 1500 rpm						
			p = 0 bar (0 psi)		p = 140 bar (2000 psi)		p = 240 bar (3500 psi)		p = 7 bar (100 psi)		p = 140 bar (2000 psi)		p = 240 bar (3500 psi)		
			in <sup>3</sup> /rev	cm <sup>3</sup> /rev	gpm	lpm	gpm	lpm	gpm	lpm	hp	kw	hp	kw	hp
P1 & P2	042	8.07	132.3	52.50	198.5	49.87	188.5	47.96	181.3	6.97	5.2	66.25	49.4	110.77	82.6
	045	8.70	142.4	56.51	213.6	53.86	203.6	51.98	196.5	7.24	5.4	70.94	52.9	118.95	88.7
	050	9.67	158.5	62.88	237.7	60.24	227.7	58.36	220.6	7.64	5.7	78.45	58.5	131.82	98.3
	052	10.00	164.8	65.40	247.2	62.75	237.2	60.87	230.1	7.78	5.8	81.53	60.8	136.92	102.1
	057	11.02	180.7	71.71	271.1	69.07	261.1	67.19	254.0	8.18	6.1	89.04	66.4	143.35	106.9
	062	12.00	196.7	78.04	295.0	75.40	285.0	73.52	277.9	8.58	6.4	96.42	71.9	162.67	121.3
	066	13.00	213.3	84.63	319.9	81.98	309.9	80.11	302.8	8.98	6.7	104.20	77.7	175.94	131.2
	072	13.86	227.1	90.11	340.6	87.46	330.6	85.58	323.5	9.25	6.9	110.77	82.6	187.07	139.5
	085 <sup>1,2)</sup>	16.40	269.8	107.00	404.7	105.21	397.7	--	--	9.78	7.3	87.56	65.3	--	--

1) 085 = 2000 RPM max.

2) 085 = 75 bar (1100 psi) cont. 085 = 90 bar (1300 psi) max. int.